

# *Parts and Services, LLC*

P. O. Box 696 – 97 South Pomperaug Avenue  
Woodbury, CT 06798-0696

Phone: 203-263-5619

Fax: 203-263-0601

[sales@partsandservicesllc.com](mailto:sales@partsandservicesllc.com) • [www.partsandservicesllc.com](http://www.partsandservicesllc.com)

## **BARRIER REPLACEMENT PARTS**

### **PRICE LIST**



**EFFECTIVE FEBRUARY 1, 2016**

PRICES SUBJECT TO SUBJECT CHANGE  
NOT RESPONSIBLE FOR TYPOGRAPHICAL ERRORS

# MATERIALS

## EXTRUSION

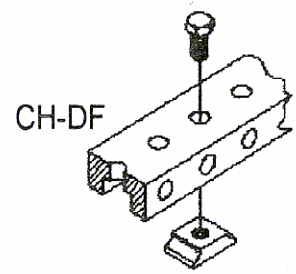
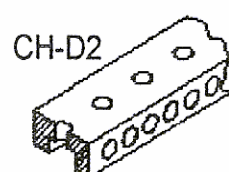
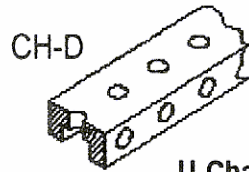
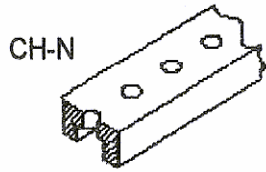

**U-Channel**  
Aluminum alloy--Black anodized

SPECIFY PART # AND LENGTH	\$/INCH
CH-N	1.60
CH-D	1.75
CH-D2	1.90
CH-DF (w/Fasteners)	2.65

## RODS & HAIRPINS

Specify: RDx\_\_\_" (Alum.)  
RD-STx\_\_\_" (Steel)

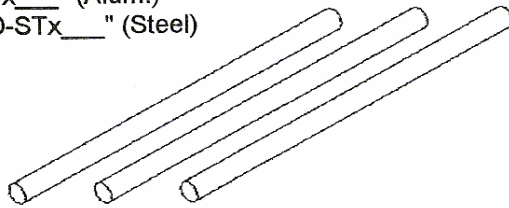

Specify: HPx\_\_\_" (Alum.)  
HP-STx\_\_\_" (Steel)

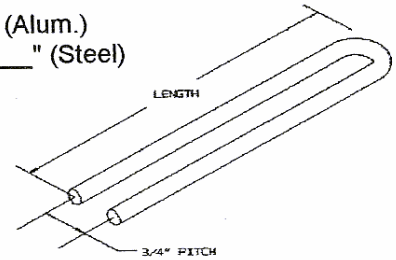

LENGTH	\$/IN		\$/IN	
	RD	RD-ST	HP	HP-ST
0 - 72	.16	.12	.34	.26

# MATERIALS

## PANEL PLATES

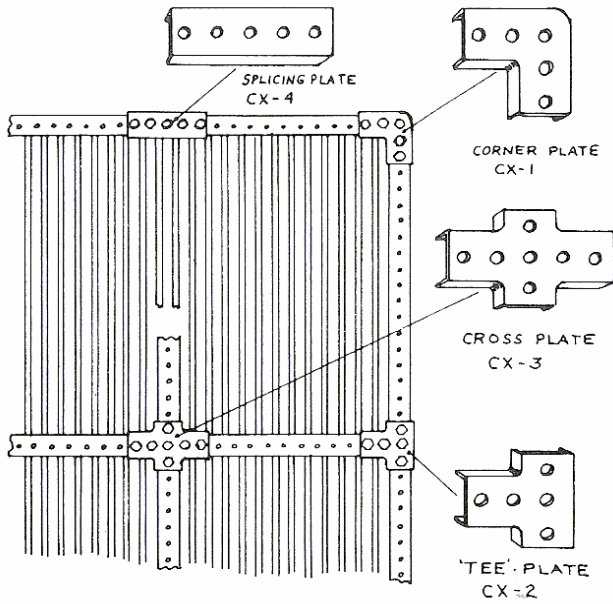

NAME	PART #	\$/PLATE	
		PLATE ONLY	W/FASTENERS
Corner Plate	CX-1	10.50	14.25
Tee Plate	CX-2	12.75	16.25
Cross Plate	CX-3	24.25	35.25
Splicing Plate -5 Hole-	CX-4	9.00	17.00
Splicing Plate -9 Hole-	CX-5	12.75	26.75
Splicing Plate -2 Hole-	CX-6	4.25	7.50
Splicing Plate -3 Hole-	CX-7	5.25	10.00

## FASTENERS

TYPE	SIZE	LENGTH	HEX HEAD	"TAMPRUF"
			\$/EACH	\$/EACH
HEX HEAD MACHINE SCREWS	1/4-20	5/8	.75	
		13/32	.75	
	1/4-28	7/8	.75	1.75
		1-1/4	.75	2.00
HEX HEAD CAP SCREWS	1/4-28	1/2	.75	1.75
		1-1/4	.75	
		1-1/2	1.00	
		1-3/4	1.00	
	5/16-18	1/2	1.00	
		5/8	1.00	
		7/8	1.00	
		1	1.00	3.50
		1-1/4	1.00	3.50
		1-1/2	1.00	
		1-3/4	1.00	
		2	1.00	4.50
2-1/4	1.00			
2-1/2	1.00			

## MATERIALS

TYPE		SIZE	LENGTH	\$/EACH
SOCKET CAP SCREWS		5/16-18	1	1.00
SOCKET SET SCREWS		3/8-24	5/8	1.00
			1	1.00
			1-1/2	1.00
HEX NUTS		1/4-28		.75
		5/16-18		.75
		3/8-24		.75
SQUARE NUTS		1/4-28		.75
"TEE" NUTS		1/4-20		.75
TAB WELD NUTS	SINGLE	1/4-28		.75
		5/16-18		.75
	DOUBLE	1/4-28		.75
	OFFSET	5/16-18		.75
FLANGE NUTS		5/16-18		.75
		3/8-24		.75
JAM NUTS		5/8-11		.75
MOUNTING SCREWS	HEX HEAD CAP SCREWS	3/8-24	1	1.00

Mounting Screws available in 1/2 inch increments up to 8 inches. Prices on request.

## **CLAMP ASSEMBLIES**

NAME	PART #	\$/PART
Bar Clamp w/Fasteners	BC	4.50
Rod Clamp w/Fasteners	RC	
End Clamp w/Fasteners	EC	

## **TOOLS All prices are net**

SPECIAL SOCKET FOR "TAMPRUF" SCREWS	FOR 1/4 SCREWS	36.00
	FOR 5/16 SCREWS	88.00
HANDLE FOR "TAMPRUF" SOCKETS	FOR 1/4 SCREWS	19.50
	FOR 5/16 SCREWS	42.50

# PANELS

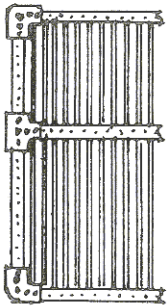

F

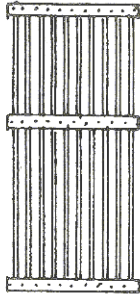

R

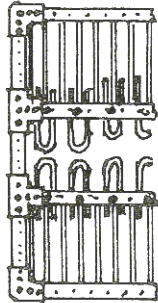

FA



RA

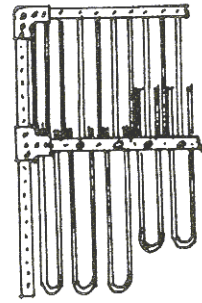

FRA

Prices given in \$ per inch of panel length plus panel constant where applicable.					
PANEL HEIGHT IN INCHES - TO	PANEL CONSTRUCTION				
	F \$/IN. + Constant	R \$/IN.	FA \$/IN. + Constant	RA \$/IN.	FRA \$/IN. + Constant
0 - 11	8.50 + 68.00	8.50	21.90 + 135.00	11.50	11.50 + 72.00
11 - 16	9.20 + 84.00	9.20	21.90 + 135.00	12.30	12.30 + 87.00
16 - 21	12.75 + 116.00	12.75	21.90 + 135.00	13.50	13.50 + 104.00
21 - 26	13.90 + 132.00	13.90	22.85 + 152.00	14.25	14.25 + 120.00
26 - 31	15.25 + 149.00	15.25	22.85 + 167.00	18.50	18.50 + 158.00
31 - 36	18.90 + 172.00	18.90	24.60 + 184.00	20.00	20.00 + 173.00
36 - 41	20.70 + 196.00	20.70	25.25 + 196.00	21.35	21.35 + 191.00
41 - 46	21.25 + 214.00	21.25	26.90 + 215.00	24.60	24.60 + 207.00
46 - 51	24.00 + 245.00	24.00	27.60 + 230.00	25.90	25.90 + 245.00
51 - 56	26.50 + 265.00	26.50	32.65 + 265.00	27.25	27.25 + 261.00
56 - 61	27.50 + 278.00	27.50	34.15 + 279.00	32.10	32.10 + 279.00
61 - 66	30.40 + 313.00	30.40	35.25 + 293.00	32.75	32.75 + 293.00
66 - 71	31.60 + 329.00	31.60	39.85 + 329.00	33.65	33.65 + 332.00
71 - 76	32.20 + 344.00	32.20	41.40 + 347.00	37.25	37.25 + 350.00

Add \$ 1.00 per H.P. for "Tampruf" Screws.

# PANELS

## INCLINABLE PANELS

The following tables for inclinable panels show the panel price only. It does not include connectors or mounts.

"R" Inclinable Panels

PANEL HEIGHTS OVER - TO	\$/PANEL								
	TO 18	21	24	27	30	33	36	39	42
0 - 16	479	552	607	657	716	751	835	900	963
16 - 21	562	639	716	792	866	944	1017	1094	1173
21 - 26	584	666	740	825	897	984	1060	1138	1263
26 - 31	608	691	776	857	941	1029	1109	1187	1270
31 - 36	672	761	857	952	1036	1138	1153	1322	1415
36 - 41	700	801	897	990	1094	1187	1287	1386	1487
41 - 46	715	825	924	1029	1133	1229	1326	1431	1532

"F" Inclinable Panels

PANEL HEIGHTS OVER - TO	\$/PANEL								
	TO 18	21	24	27	30	33	36	39	42
0 - 16	562	627	691	753	817	866	932	990	1054
16 - 21	671	741	825	897	970	1054	1133	1203	1283
21 - 26	703	785	860	944	1029	1099	1182	1259	1338
26 - 31	741	833	913	997	1078	1165	1245	1326	1414
31 - 36	852	941	1034	1133	1221	1310	1414	1496	1599
36 - 41	890	990	1090	1184	1287	1382	1474	1580	1678
41 - 46	926	1034	1138	1232	1333	1439	1535	1643	1745

## CLEAR PANELS

PANEL HEIGHTS OVER - TO	\$/PANEL													
	TO 18	21	24	27	30	33	36	39	42	48	54	60	66	72
0 - 16	212	238	254	278	303	328	352	377	397	432	479	527	573	624
16 - 21	268	283	316	340	370	398	439	457	489	530	591	654	704	763
21 - 26	298	329	365	398	438	469	503	541	573	635	701	769	839	908
26 - 31	340	383	418	459	502	541	581	625	663	733	797	892	972	1053
31 - 36	383	426	477	521	570	611	663	701	750	834	921	1015	1106	1205
36 - 41	423	478	525	579	635	683	735	783	840	934	1031	1133	1239	1344
41 - 46	468	524	581	637	696	751	813	870	926	1031	1145	1251	1391	1493

## AUXILIARY PANELS

Roof Sections, Side Shields, etc.

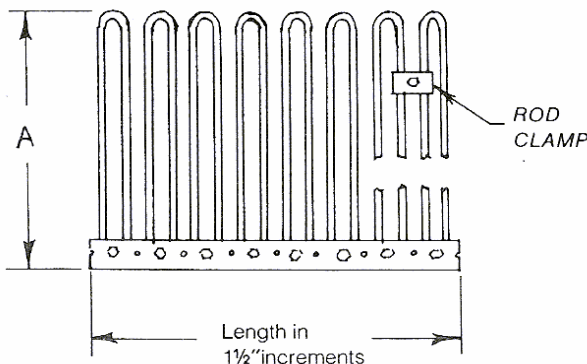

Hairpin Material	Height "A"		\$/in of Length
ALUMINUM	Up to 9		7.00
	10 to 16	w/Rod Clamps	10.75
	17 to 21		11.70
STEEL	Up to 11		8.65
	12 to 18	w/Rod Clamps	13.95
	19 to 25		15.50
	26 to 31		17.30
CONNECTOR PRICES	For Roof Section add \$ 12.10 per panel.		
	For Side Shields add \$ 36.25 per panel.		

# INSERTS

Tables include insert price only. Appropriate connector prices MUST be added as required.

## LADDER INSERT

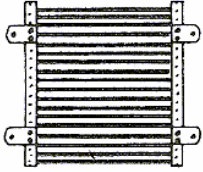

LI

INSERT HEIGHT IN INCHES	\$/INSERT PANEL LENGTH									
	4-1/2	7-1/2	10-1/2	13-1/2	16-1/2	19-1/2	22-1/2	25-1/2	28-1/2	31-1/2
0 - 13	49	80	92	132	156	194	215	247	279	308
13-3/4 - 22	54	92	132	172	209	247	279	322	356	398
22-3/4 - 42	108	145	194	228	279	322	367	408	462	502

## ADJUSTABLE INSERT

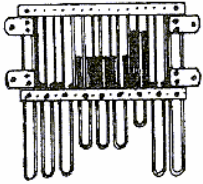

AI

INSERT HEIGHT IN INCHES	\$/INSERT PANEL LENGTH										
	6	9	12	15	18	21	24	27	30	33	
8-1/2 - 13-3/4	80	110	147	185	225	261	296	332	369	403	
14-1/2 - 26-1/2	86	129	172	213	255	298	344	385	426	470	

## 4 WAY INSERT

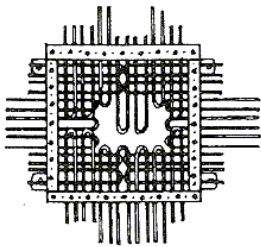

4WI

INSERT HEIGHT IN INCHES	\$/INSERT PANEL LENGTH					
	7	8-1/2	10	11-1/2	13	22
5-1/2 - 13	255	277	305	323	346	482
14-1/2 - 17-1/2	317	333	360	383	408	560
19 - 22	378	398	426	461	489	655

## DROP LADDER INSERT

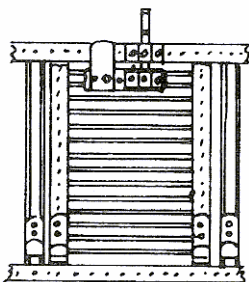

DLI — Drop Ladder Insert

SPECIFY DLI- DROP LADDER INSERT		
HEIGHT	\$ PER UNIT	
	LENGTH OF LIFT GATE IN INCHES	
	UP TO 13	13-3/4 TO 22
7-1/2	226	248
10-1/2	248	279
13-1/2	279	322

# INSERTS

## EMPTY INSERT

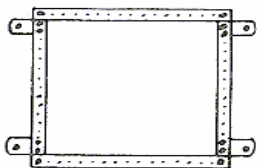

EI

INSERT HEIGHT IN INCHES	\$/INSERT PANEL LENGTH			
	7	10	13	22
5-1/2 - 13	170	184	194	228
14-1/2 - 17-1/2	185	196	210	239
19 - 22	210	217	228	261

## LIFT GATE

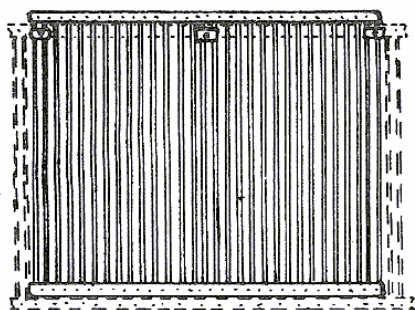

LG Lift Gate

SPECIFY LG- LIFT GATE								
HEIGHT	\$ PER UNIT							
	LENGTH OF LIFT GATE IN INCHES							
	11	14	18	22	25	29	33	36
0 - 11	145	168	196	234	255	279	309	335
11 - 16	149	184	210	250	279	309	353	371
16 - 21	194	234	281	333	378	424	477	520

## LIFT GATE - ADJUSTABLE

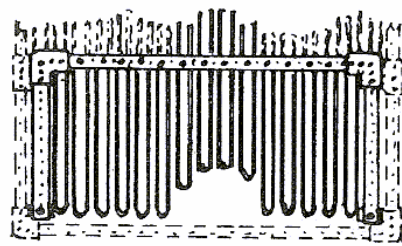

LG-A Lift Gate-Adj.

SPECIFY LG- LIFT GATE								
HEIGHT	\$ PER UNIT							
	LENGTH OF LIFT GATE IN INCHES							
	11	14	18	21	24	28	31	34
0 - 11	184	210	241	268	292	323	346	370
11 - 16	247	292	342	383	422	478	525	565
16 - 21	266	308	370	418	462	525	571	614

## CLEAR INSERT

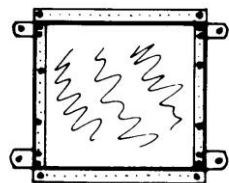

LXI

INSERT HEIGHT IN INCHES	\$/INSERT PANEL LENGTH									
	7	8-1/2	10	11-1/2	13	25	37	49	61	73
0 - 13-3/4	129	139	150	157	168	261	350	440	527	619
14-1/2 - 19	153	167	182	194	211	324	440	555	674	1374
19-3/4 - 25	175	200	217	234	251	396	543	686	834	980
25-3/4 - 31	205	230	250	271	294	471	605	821	996	1171



# INSERTS

## LADDER ROD INSERT – Steel Hairpins

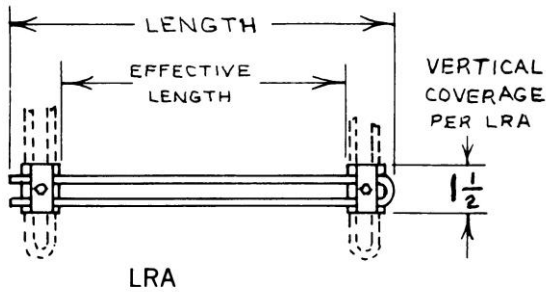

PRICING FOR LRA  
USE STEEL HAIRPIN PRICING FROM TABLE NO. 2  
PLUS \$21.00 FOR CLAMPS \*\*

## INSERT CONNECTOR SETS

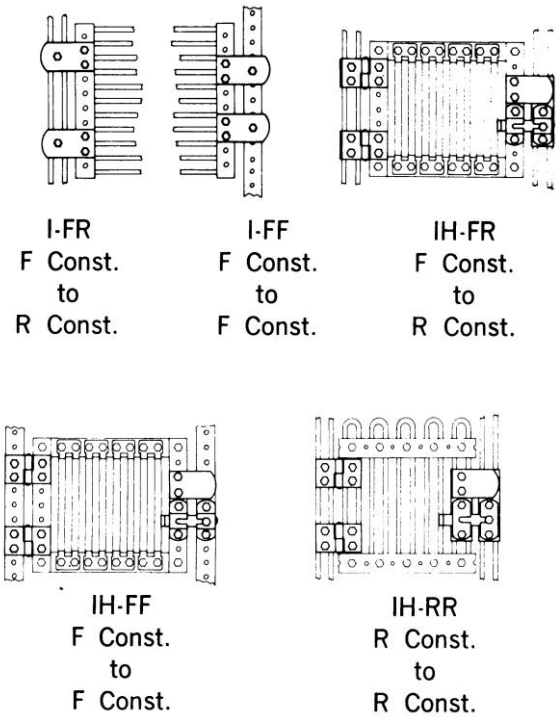

SPECIFY PART #	INCLUDES	PARTS ONLY	ASSEMBLED INTO PANEL
I-FR (Std.)	(4) PANEL PLATES (4) ROD CLAMPS PLUS FASTENERS	44.00	65.00
I-FF	(4) PANEL PLATES PLUS FASTENERS	27.50	48.50
IH-FR	(2) HINGES (2) PIN CLAMPS PLUS FASTENERS (1) IL-FF	91.50	123.00
IH-FF	(2) HINGES PLUS FASTENERS (1) IL-FF	81.00	102.00
IH-RR	(2) HINGES (4) PIN CLAMPS PLUS FASTENERS (1) IL-RR	102.50	133.50

See CONNECTOR section of this price list for prices of listed by symbol.

Prices ON REQUEST for other parts.

# MOUNTS

## HINGE MOUNTS

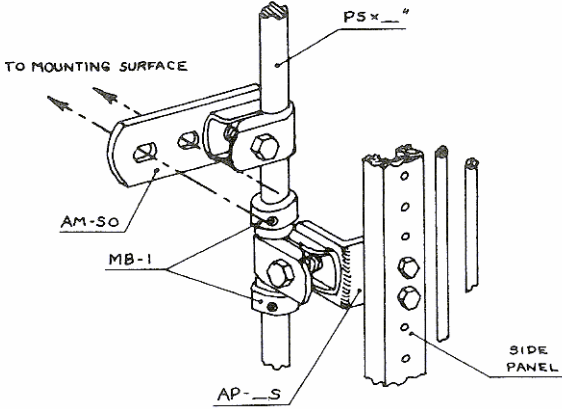

HM-1

- Includes:
- (4) AM-SO
  - (4) AP-\_\_S (Appropriate to Panel Construction)
  - (6) MB-1
  - (2) PS x \_\_" (Appropriate Length)

Price Complete \$ 409.50

HM-2

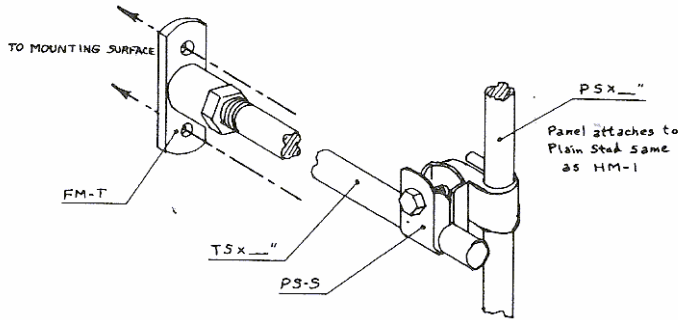

- Includes:
- (4) FM-T
  - (4) TS x \_\_" (Appropriate Length)
  - (4) PS-S
  - (4) AP-\_\_S (Appropriate to Panel Construction)
  - (6) MB-1
  - (2) PS x \_\_" (Appropriate Length)

Price Complete \$ 556.50

HM-3

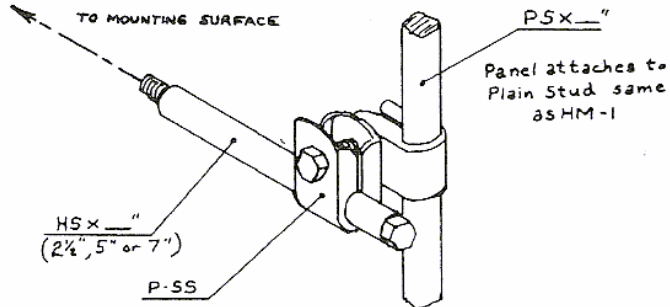

- Includes:
- (4) HS x \_\_" (Appropriate Length)
  - (4) PS-S
  - (4) AP-\_\_S (Appropriate to Panel Construction)
  - (6) MB-1
  - (2) PS x \_\_" (Appropriate Length)

Price Complete \$ 483.00

## Hinge Mount Data

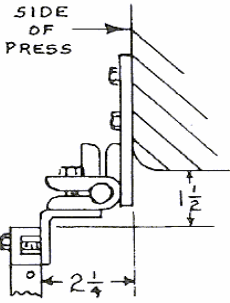

Fig. 1

Hinge mount hardware can be installed in various positions to accommodate panels that are wider or narrower than the mounting frame. Fig. 1 shows one side of a typical HM-1 mount extended the panel outward from the side. Fig 2 shows the same mounting hardware reversed and rebolted to extend the panel inward. This system will allow panels from 4-1/2" wider to 3" narrower than the frame to be mounted with a standard HM-1. Similar adjustments can be made when an HM-2 or HM-3 mount is used.

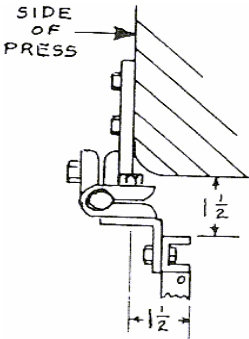
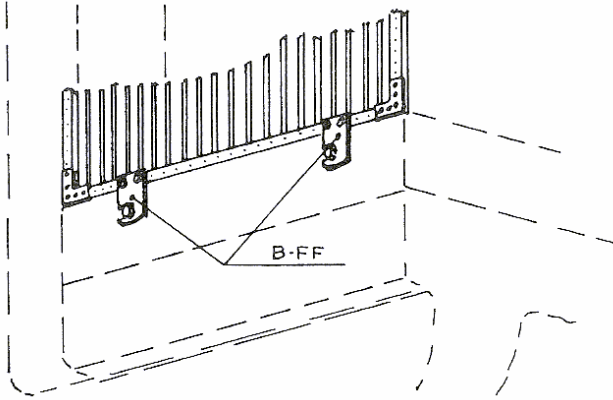

Fig. 2

# MOUNTS

## SIDE MOUNTS



SM-1 - Direct

Includes:

- (4) B-FF
- (4) Panel Connectors (Not Illustrated)

Price Complete \$ 204.75

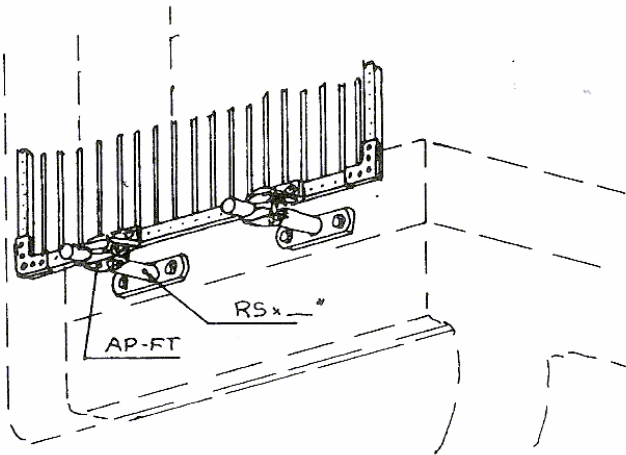

SM-2 - Extended

Includes:

- (4) RS x \_\_\_" (Appropriate Length)
- (4) AP-FT
- (4) Panel Connectors (Not Illustrated)

Price Complete \$ 372.75

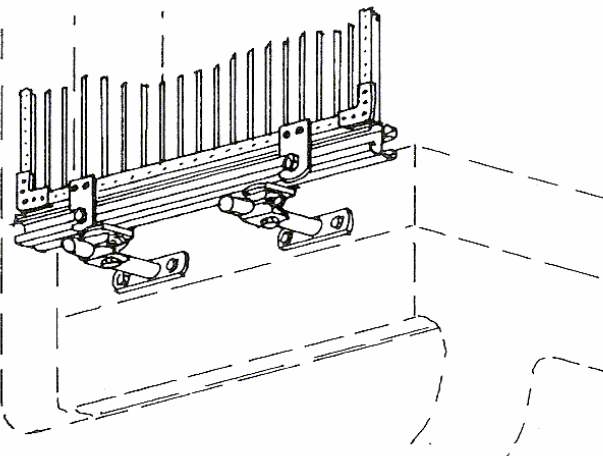

SM-3 - Adjustable

To be quoted by factory.

# MOUNTS

## POST MOUNTS

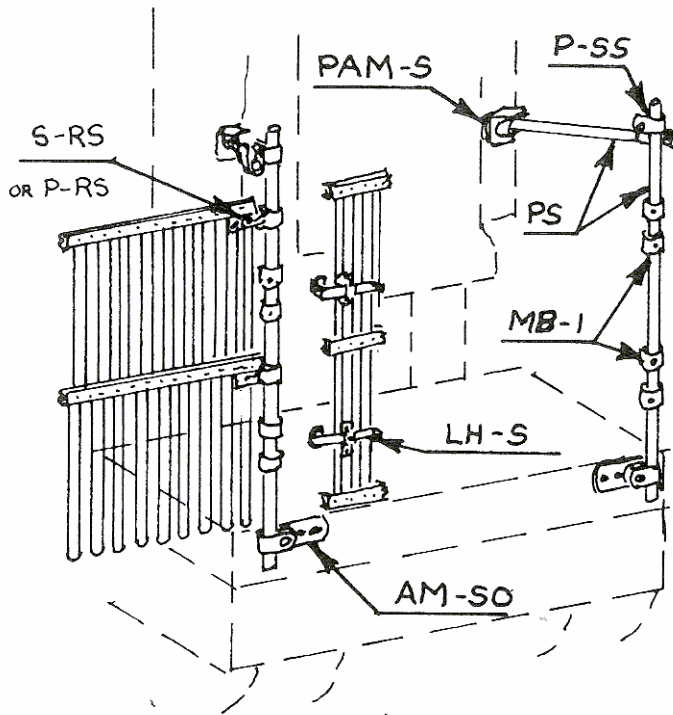

PM-1 - Direct

Includes:

- (2) AM-SO
- (4) PS x \_\_" (Appropriate Length)
- (2) PAM-S
- (2) P-SS
- (4) S-RS or P-RS
- (4) LH-\_\_S
- (8) MB-1

Price Complete \$ 504.00

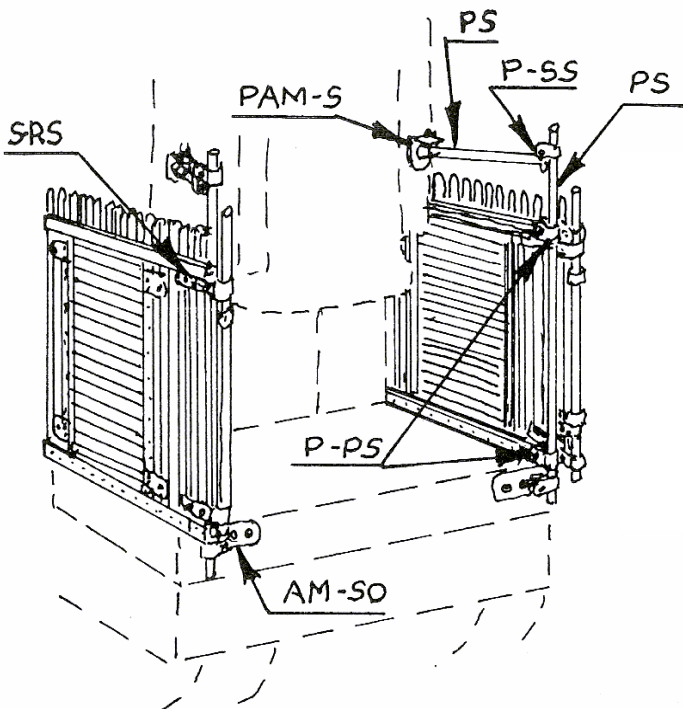

PM-2 - Front Panel Extended

Includes:

- (2) AM-SO
- (6) PS x \_\_" (Appropriate Length)
- (2) PAM-S
- (2) PS-S
- (4) P-FS
- (4) S-RS
- (4) LH-\_\_S (Not Illustrated)
- (8) MB-1

Price Complete \$ 619.50

# MOUNTING HARDWARE

## STUDS

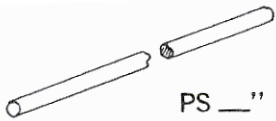

**Plain Stud** — 5/8" Dia. to fit angle mounts, plain face mounts and panel to stud connectors.

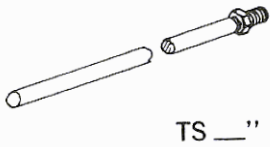

**Threaded Stud** — 5/8" Dia. 5/8-11 thread with jam nut to fit threaded face mounts.

\$ PER STUD		
LENGTH	PLAIN	THREADED
UP to 6"	13.25	19.50
7" to 12"	15.25	21.75
13" to 18"	17.50	23.75
19" to 24"	21.75	28.00
25" to 30"	23.25	29.50
31" to 36"	26.25	32.75
37" to 42"	29.00	35.25
43" to 48"	31.00	37.50
49" to 54"	34.25	40.50
55" to 60"	37.50	43.75

## TUBING - 1-1/16" OD High Yield Tubing

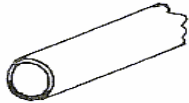

T \_\_\_"

Cutting Charge \$ 6.00 per piece

Plus \$ 7.75 per foot

## PIVOT CLAMPS

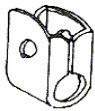

PC  
Pivot Clamp

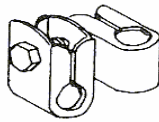

P-SS  
Stud to Stud

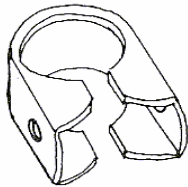

TC  
Tube Clamp

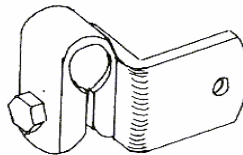

PAM-S  
Pivot Angle Mount  
Machine to Stud.

PART #	\$/UNIT
PC	14.75
TC	17.75
P-SS	31.50
P-ST	32.50
P-TT	33.75
PAM-S	23.25

P-ST = Stud to Tube and P-TT = Tube to Tube are Not Illustrated

# MOUNTING HARDWARE

## PARTS AND SPECIAL MOUNTS

FM-P  
FM-T

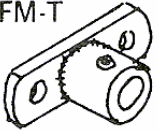

Face Mount  
Plain or  
Threaded



FM-PO  
FM-TO

Offset Face  
Mount — Plain  
or Threaded

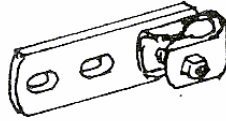

AM-SO

Offset Angle Mount to Stud



MB-1

Mount Bushing

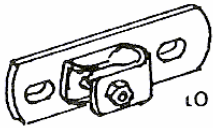

AM-S  
to Stud

PART #	\$/UNIT
AM-S	26.25
AM-SO	26.25
FM-P	30.50
FM-PO	30.50
FM-T	30.50
FM-TO	30.50
MB-1	7.00

## HOLLOW STUD MOUNTS - Lengths of 2-1/2", 5" and 7"

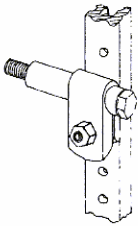

HSM \_\_\_"

**Hollow Stud Mount** —  
To attach 'F' panel to  
press, perpendicular to  
mounting surface.

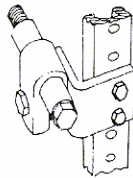

HSAM \_\_\_"

**Hollow Stud Angle Mount** —  
To attach 'F' panel to  
press, parallel with  
mounting surface.

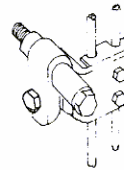

HSAM-R \_\_\_"

**Hollow Stud Angle Mount** —  
To attach 'R' panel to  
press, parallel with  
mounting surface.

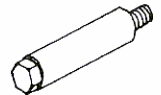

HS \_\_\_"

**Hollow Stud** — 5/8" O.D.  
3/8" I.D. with appropriate  
length bolt.

	\$ PER UNIT		
	2-1/2"	5"	7"
HSM ___"	16.25	20.25	22.50
HSAM ___"	26.25	30.50	32.25
HSAM-R ___"	26.25	31.25	34.50
HS ___"	9.50	13.50	16.25

# CONNECTORS

## PANEL TO PANEL

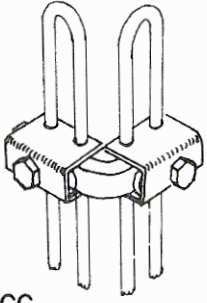

**A-CC**  
Angle — 'C' panel to 'C' panel.

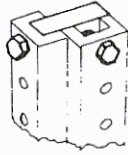

**A-FF**  
Angle — 'F' panel to 'F' panel.

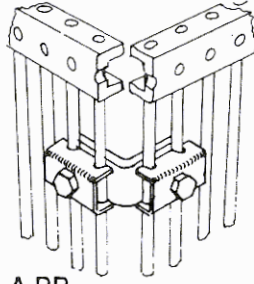

**A-RR**  
Angle — 'R' panel to 'R' panel.

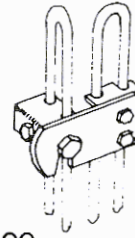

**AB-CC**  
Angle - Bayonet 'C' panel to 'C' panel.

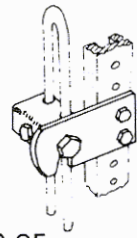

**AB-CF**  
Angle - Bayonet — 'C' panel to 'F' panel.

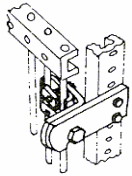

**AB-RF**  
Angle - Bayonet — 'R' panel to 'F' panel.

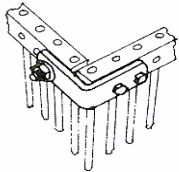

**ABL-RR**  
Angle - Bayonet - Long 'R' panel to 'R' panel.

PART #	\$/UNIT
A-CC	15.75
A-FF	8.00
A-RR	15.75
AB-CC	22.25
AB-CF	14.75
AB-FF	14.75
AB-RF	14.75
AB-RR	29.50
ABL-RR	15.75
B-FF	11.75
B-FR	20.00
B-RF	20.00
B-RR	24.25

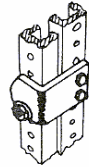

**AB-FF**  
Angle - Bayonet — 'F' panel to 'F' panel.

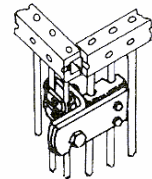

**AB-RR**  
Angle - Bayonet — 'R' panel to 'R' panel.

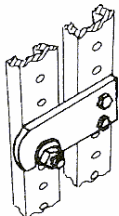

**B-FF**  
Bayonet (in line) 'F' panel to 'F' panel.

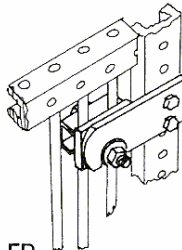

**B-FR**  
Bayonet (in line) 'F' panel to 'R' panel.

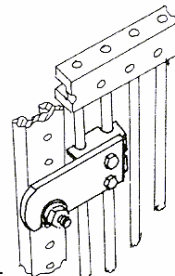

**B-RF**  
Bayonet (in line) 'R' panel to 'F' panel.

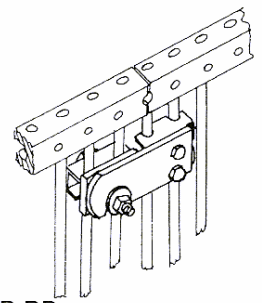

**B-RR**  
Bayonet (in line) 'R' panel to 'R' panel.

# CONNECTORS

## PANEL TO POST

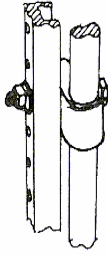

P-FS  
Pivot Conn.  
'F' panel to stud

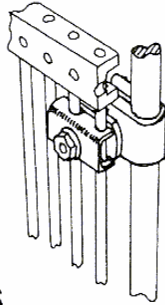

P-RS  
Pivot Conn.  
'C' or 'R' panel to stud

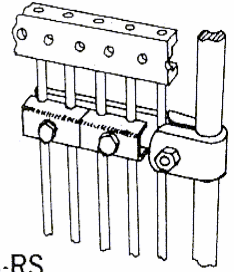

S-RS  
Side Conn.  
'C' or 'R' panel to stud

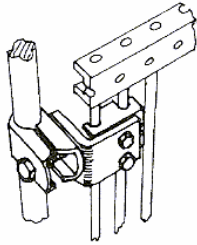

AP-RS  
Angle Pivot Conn.  
'R' panel to stud

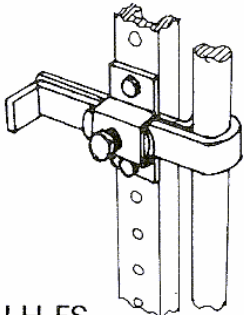

LH-FS  
Hook Latch Conn.  
'F' panel to stud

PART #	\$/UNIT
AP-FS	25.25
AP-FT	26.25
AP-RS	28.50
AP-RT	29.50
LH-FS	28.50
LH-FT	28.50
LH-RS	32.50
LH-RT	32.50
P-FS	19.00
P-FT	20.00
P-RS	24.25
P-RT	25.25
S-RS	29.50
S-RT	30.50

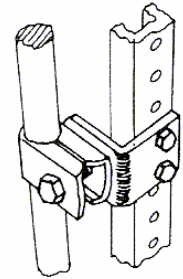

AP-FS  
Angle Pivot Conn.  
'F' panel to stud

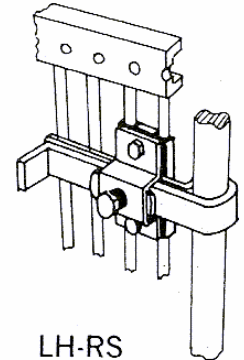

LH-RS  
Hook Latch Conn.  
'R' panel to stud



# CONNECTORS

## PANEL CONNECTOR SETS

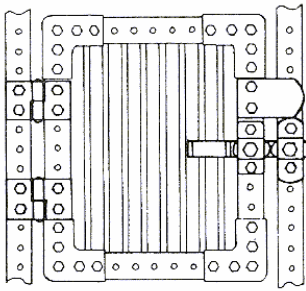

H-FF Hinged Panel  
'F' panel to 'F' const.

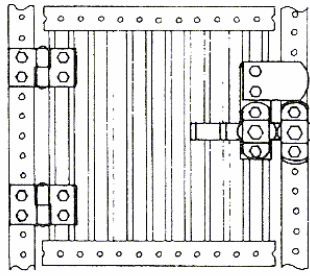

H-FR Hinged Panel  
'R' panel to 'F' const.

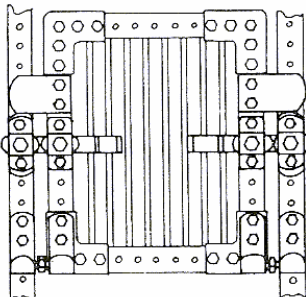

DG-F Drop Gate  
'F' panel to 'F' const.

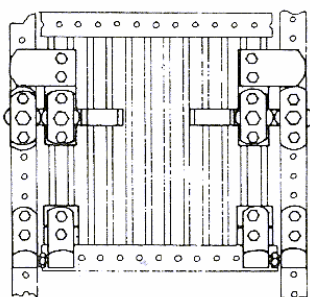

DG-R Drop Gate  
'R' panel to 'F' const.

PART #	\$/UNIT	ASSEMBLED
H-FF (2) HINGES (1) GL-FF Plus fasteners	88.00	109.25
H-FR (2) HINGES (1) GL-RF Plus fasteners	79.00	110.25
DG-F (2) DROP HINGES (1) GL-FF Plus fasteners	145.00	166.00
DG-R (2) DROP HINGES (1) GL-RF Plus fasteners	168.00	199.50

## LATCHES

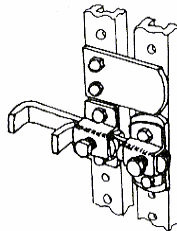

GL-FF Gate Latch  
'F' panel to 'F' const.

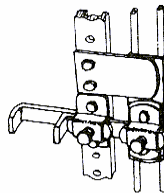

GL-FR Gate Latch  
'F' panel to 'R' const.

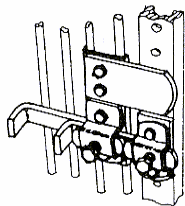

GL-RF Gate Latch  
'R' panel to 'F' const.

PART #	\$/UNIT
GL-FF	44.00
GL-FR	56.75
GL-RF	56.75
GL-RR	52.50
IL-FF	36.75
IL-FR	42.00
IL-RR	47.25

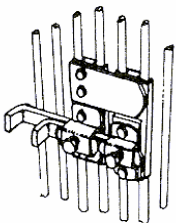

GL-RR Gate Latch  
'R' panel to 'R' const.

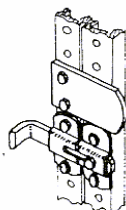

IL-FF Insert Latch  
'F' insert to 'F' const.

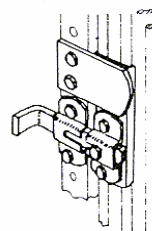

IL-FR Insert Latch  
'F' insert to 'R' const.

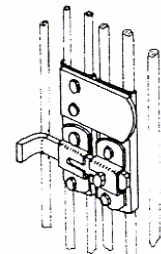

IL-RR Insert Latch  
'R' insert to 'R' const.

# CONNECTORS

## HINGES

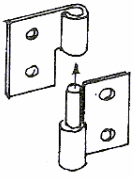

BUTT HINGE  
HC-3 Left Hand

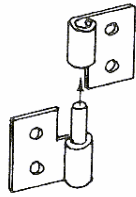

BUTT HINGE  
HC-2 Right Hand

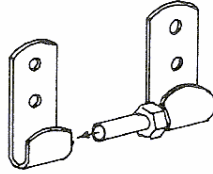

DROP HINGE  
DH-3 Left Hand

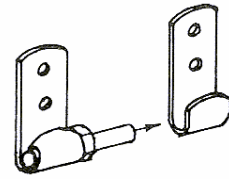

DROP HINGE  
DH-2 Right Hand

Butt Hinges are offered here as replacement parts. Prices are for one hinge only. You must specify Left or Right Hand and the number desired. Standard pairs will be (1) Left and (1) Right so the hinge pins will oppose each other and the door will be contained when open. Using (2) Lefts or (2) Rights will allow the door to be easily removed when open.

Drop Hinges are offered here as replacement parts. Prices are for one side only. You must specify Left or Right Hand and the number desired.

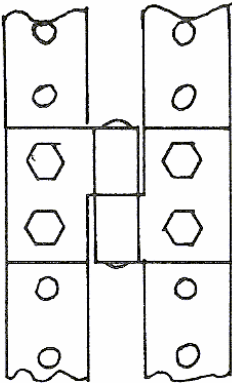

HC-FF  
'F' const. to 'F' const.

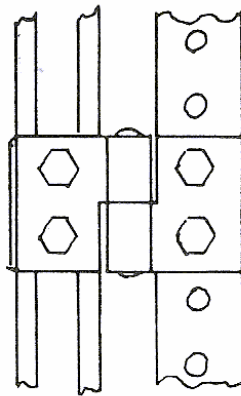

HC-RF  
'R' const. to 'F' const.

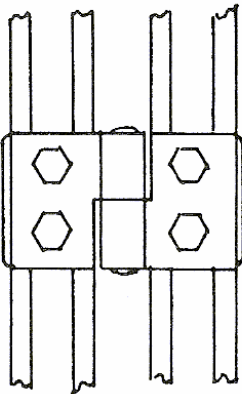

HC-RR  
'R' const. to 'R' const.

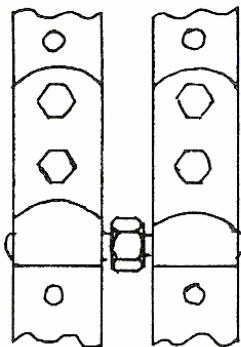

DH-FF  
'F' const. to 'F' const.

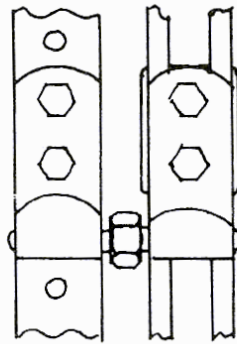

DH-RF  
'R' const. to 'F' const.  
Fasteners may be reversed to accommodate Drop Ladder Inserts

PART #		\$/UNIT
BUTT HINGE	HC-2	15.75
	HC-3	15.75
DROP HINGE	DH-2	22.00
	DH-3	22.00
HC-FF	LH RH	28.50
HC-RF	LH RH	27.50
HC-RR	LH RH	32.50
DH-FF	LH RH	28.50
DH-RF	LH RH	27.50

# SPRING LIFT

MOUNTING KIT: \$ 1,375.00

Replacement Springs: Different weights are used in sets of two, four or six to accommodate a variety of panel weights. When a spring breaks or wears out from use, it is recommended that all springs are replaced.

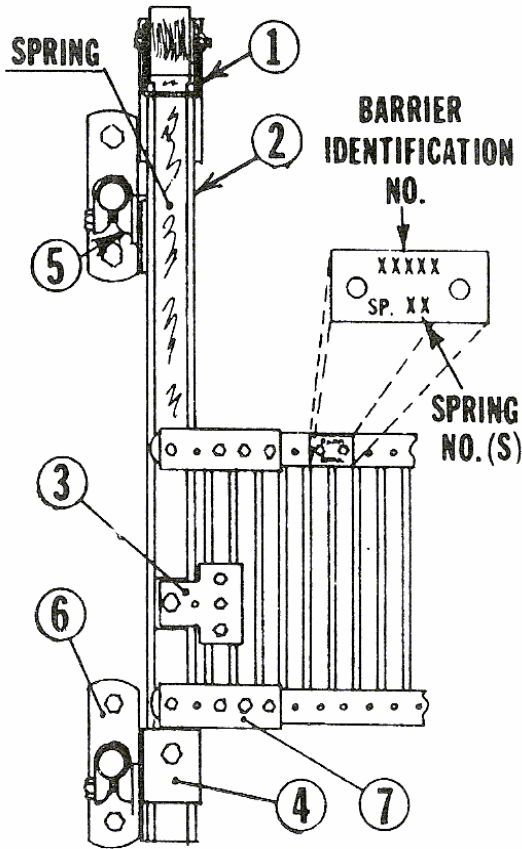

SPECIFY		\$/UNIT
SLT # _____ SPRING		84.00
COMPLETE Spring Unit Includes: Spring, "U" clamps, Mounting Channel & Fasteners	1 SPRING	168.00
	2 SPRINGS	288.75
	3 SPRINGS	409.00
SLA # _____ SPRING(S)		

SPRING #	COLOR CODE	THICKNESS	LOAD LBS.
SLT-0	BROWN	.010	3.2
SLT-1	RED	.012	6.4
SLT-3	WHITE	.014	9.6
SLT-4	BLUE	.016	12.8
SLT-5	GREEN	.018	16.0

CODE	PART #	NAME	\$/UNIT
1	SLA	Spring Lift Assembly	See Above
2	PS-501	Power Strut	31.50/ft
3	SL-LA	Spring Lift-Lock Assy.	31.50
4	GR-S	Guide Rail Stop	10.50
5	CO-RC	Outside Rail Connector	29.50
6	RS x ____"	Rail Support x ____"	44.00
7	SLB	Spring Lift Bearing Assy.	65.25
	SLB-1	Spring Lift Bearing Only	45.25

## LIMIT SWITCH BRACKET

BRACKET #		\$/UNIT
LSB-1	PANEL	61.00
LSB-2	SPRING LIFT	61.00
LSB-3	COUNTERWEIGHT	61.00

# COUNTERWEIGHT

MOUNTING KIT: \$ 3,200.00

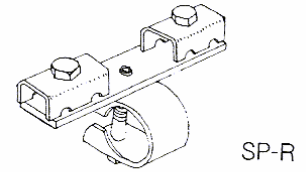
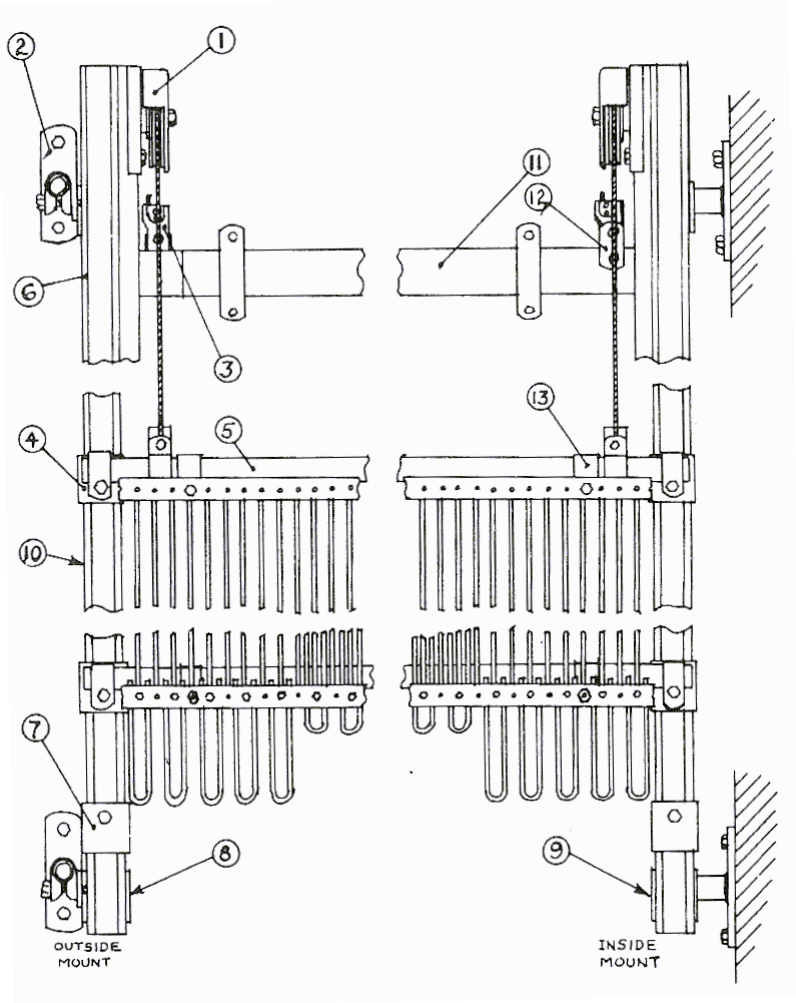

SP-R  
Side Plate Connector  
Tube to Rods

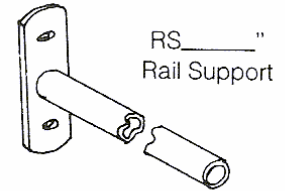

RS \_\_\_\_\_"  
Rail Support



GR-S  
Guide Rail Stop

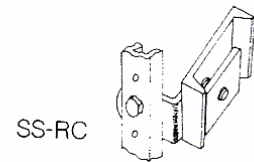

SS-RC  
Side Shield Connector  
'F' Const. to Rail

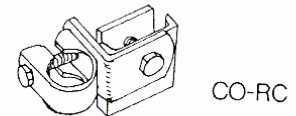

CO-RC  
Counterweight - Outside  
Rail Connection

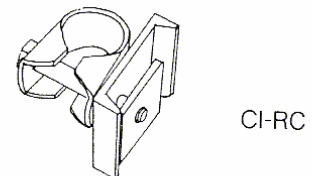

CI-RC  
Counterweight - Inside  
Rail Connection

CODE	PART #	NAME	\$/UNIT
1	PA	Pulley Assembly	157.50
2	RS x ____"	Rail Support x ____"	44.00
3	CAC	Cable Assembly	63.00
4	CI-RC	C't'b. Inside Rail Connector	21.00
5	T_ _"	Tube	Price/Inch .65
6	PS-3345	Rails	Price/Foot 53.50
7	GR-S	Guide Rail Stop	10.50
8	CO-RC	C't'b. Outside Rail Connector	29.50
9	CI-RC	C't'b. Inside Rail Connector	21.00
10	CR	Carrier Assembly	113.50
11	CW	Counterweight	Base Price 457.00 Price/Foot 35.75
12	CB-SA	Cable Block - Single Assembly	45.25
13	SP-R	Side Plate - Connector to Rod	20.00
	SS-RC	Side Shield Connector	19.00